

**AN IMPORTANT MESSAGE FROM  
MINELAB**

The **2000** series Metal Detectors are by far the most efficient gold prospecting and treasure hunting tools that Minelab has ever developed. With the second generation **SD2100** you can expect to recover targets at far greater depths than ever before. We would ask **YOU**, as a responsible detector operator, to take all due care regarding the environment.

**Minelab cannot stress enough the importance of being responsible when recovering targets. Backfill every hole you dig.**

If care and consideration is taken during and after the removal of targets, especially with respect to the backfilling of holes, then this should ensure the continued access to areas for prospecting and treasure hunting. It will also ensure that the pristine condition of our beautiful bushland, forests and dryland areas are maintained with a minimum of impact.

Minelab is working with you towards preserving our natural environment so that the benefits of gold prospecting and treasure hunting can continue to be enjoyed in the years to come.

Every prospector and treasure hunter around the world, and the staff of Minelab thank you for your continued efforts to protect the environment.

And please remember;

**DO THE RIGHT THING, FILL IN YOUR HOLES!**

**CONTENTS**

<b>CONTENTS</b>	<b>2</b>
<b>QUICK START INSTRUCTIONS</b>	<b>3</b>
<b>INTRODUCTION</b>	<b>4</b>
<b>LIST OF PARTS</b>	<b>5</b>
<b>ASSEMBLY OF THE SD2100</b>	<b>7</b>
<b>THE CONTROLS</b>	<b>11</b>
<b>OPERATING INSTRUCTIONS</b>	<b>13</b>
<b>DETECTING TECHNIQUES</b>	<b>19</b>
<b>PROSPECTING TIPS</b>	<b>25</b>
<b>MAINTENANCE</b>	<b>26</b>
<b>WARRANTY</b>	<b>28</b>
<b>SPECIFICATIONS</b>	<b>29</b>

**QUICK START INSTRUCTIONS**

These instructions can be followed by operators who are familiar with the workings and general terminology of detectors. Those not familiar with detecting are advised to proceed to the Operating Instructions on page 12.

1. Switch the Power Switch to ON.
2. Set the Threshold Control so that the threshold tone is just audible.
3. Move the Coil around until interference noise is loudest. With the Coil in this position adjust the Internal Tune Control to reduce the interference.
4. Set the Internal Tone Control to produce a pitch which suits you.
5. Select Balance I with the Search Switch and ground balance the **SD2100**.
6. Select Balance II with the Search Switch and ground balance the **SD2100**.
  - Note: Ground balance by listening to the pitch of the tone as well as its volume. The **SD2100** will always make the volume go up, not quieten as other detectors do. The pitch of the tone will go both up and down.
7. Select Search position.
8. Start searching.

We do recommend that you take the time to read this manual thoroughly to help you get the most out of your new **SD2100**.

**INTRODUCTION**

Thank you for purchasing the new Minelab **SD2100**. The **SD2100** is a development of the **SD2000**. We at Minelab are sure that you will find this detector to be the finest available for the detection of metallic objects in highly mineralised environments. This detector can "see" deeper than any other conventional detector available on the market today and its simplicity of operation means it is easy to use for the beginner and professional alike. Its superior ability at cancelling mineralisation not only invites the discovery of new sources of precious metals, but re-opens old fields where hot ground has shielded many a nugget from the prying "eyes" of prospectors.

Minelab has studied the role that mineralisation plays in the obscuration of nuggets and has developed the new Multi Period Sensing (MPS) technique which enables detection of metallic targets, both large and small, even in

the hottest ground. Furthermore, it produces Ground Balancing which requires minimal adjustment during operation and is stable over large variations in ground mineralisation.

We trust you will find this detector a pleasure to use with its stable and effective ground balancing, superior depth capability and sensitivity.

**Electromagnetic Compatibility**  
This equipment is designed for use in remote areas away from other electrical appliances and equipment. When it is operating the **SD2100** generates an electromagnetic field which may interfere with other equipment. The **SD2100** is also a very sensitive receiver and may be interfered with by other equipment. There is a Tune Control to reduce this effect.

**LIST OF PARTS**

The **SD2100** is packed in two boxes, one for the detector and one for the 18" and 8" Monoloop Coil. Check that you have the following parts:

- a) 18" Monoloop Coil.  
(Available only as an accessory in some countries)
- b) 11" Double 'D' Coil with Skid Plate.
- c) 8" Monoloop Coil with Skid Plate.
- d) **SD2100** Control Box.
- e) Armrest (2 parts).
- f) Upper Shaft.
- g) Intermediate shaft.
- h) Fibreglass Tube for the 18" Coil.
- i) Fibreglass Tube For the 11" or 8" Coil.
- j) Handle, including Wrist Strap.
- k) Backpack.
- l) Battery and Cable assembly.
- m) Headphones.
- n) Nylon Bolts. (x4)
- o) Nylon Wing Nuts. (x4)
- p) Mains Battery Charger.
- q) 12V Battery Charger.
- r) Warranty Card.
- s) This Instruction Manual.
- t) Shoulder Balance Strap.
- u) Shoulder Balance Strap Shaft Clip.
- v) Sheepskin Armrest Cover. (Some markets may have a synthetic sheepskin)
- w) Screwdriver.
- x) Velcro Cable Straps (x3)
- y) Nylon Spacer.

**ASSEMBLY OF THE SD2100**

To assemble your **SD2100**: (Please refer to Figure 1.)

- a) Place the two Armrest halves (1) on either side of the Upper Shaft (3), ensure the bolt holes line up.
- b) Slide the two Nylon Bolts (2) through the holes, screw the Nylon Wing Nuts (4) on to the bolts by a couple of turns.
- c) Slide the "T" section on the top of the Control Box (5) in to the Armrest with the detector stand at the rear. Tighten the Nylon Wing Nuts by hand. See insert in Figure 1.
- d) Push the Armrest Cover (6) over the Armrest (1).
- e) Slide the Handle (7) on the other end of the Upper Shaft (3) and set to a comfortable position. Tighten the two screws with a small flat tipped screwdriver to hold the handle in place.
- f) Slide the Shoulder Balance Strap Shaft Clip (8) onto the Intermediate Shaft (9).
- g) Slide the Intermediate Shaft (9) into the end of the Upper Shaft (3) and snap it into place.
- h) Ensure that the 8" (16) and the 11" (10) Coils have skid plates (11&17) fitted. The 18" Coil (19) is made from wear resistant Kevlar®. However with constant abrasion it will wear through. Extra protection can be gained by covering the perimeter of the coil with a silk tape such as Leukosilk® which is available from chemists. The use of some other tapes, such as insulation tape, may result in loss of performance.

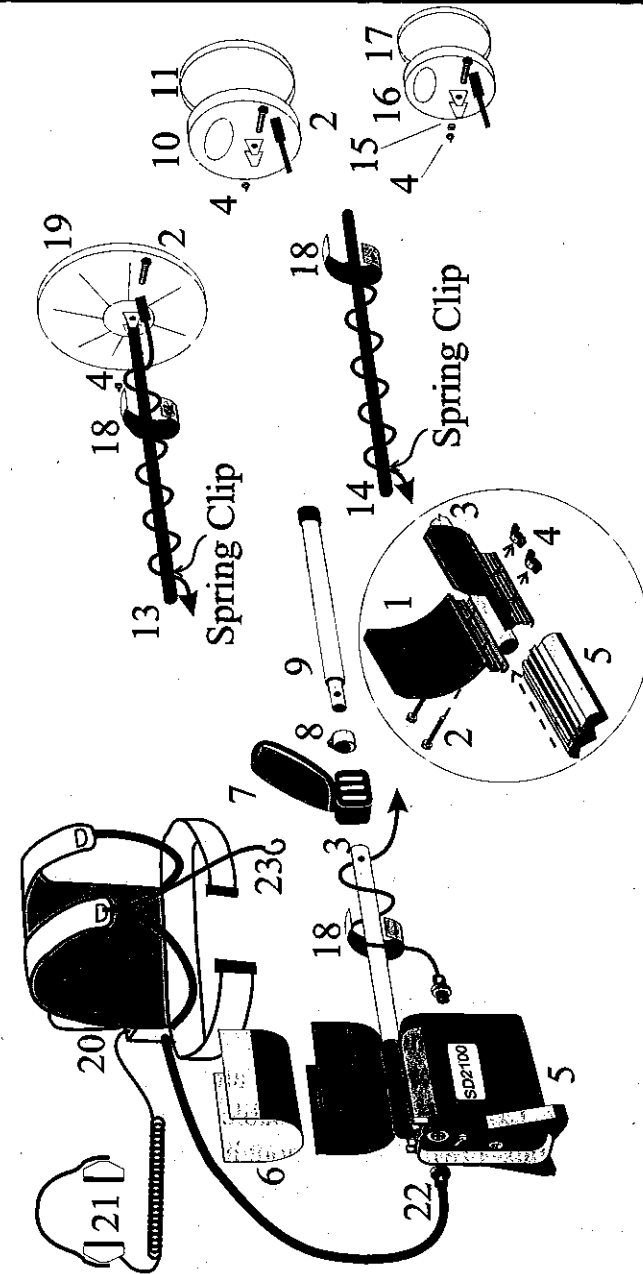

Figure 1

- i) There are 2 Fibreglass Tubes (13 & 14) supplied to allow for quick changing of coils. Both Fibreglass Tubes have 2 teardrop washers located in the pivot end, one of them (13) has 2 extra round rubber inserts in the coil pivot end. This is the tube for the 18" Coil (19). The round rubbers provide extra friction to hold the coil in the desired position. The other Fibreglass tube (14) does not have these extra rubbers and should be used with either the 8" or 11" coils. Choose the coils you wish to mount on the fibreglass tubes. Ensure the coil pivot end of the fibreglass tube has the rubber washers installed and push these in to the mounting bracket on the coil, ensure that the spring clip faces the rear of the coil. Line up the holes in the coil mounting bracket and pivot end of the fibreglass tube then push a Nylon Bolt (2) through the holes and fit a Nylon Wing Nut (4) which should be tightened by hand. If using the 8" coil the Nylon Bolt should be pushed in from the cable entry side of the coil, as the coil mounting bracket will hold the head of the bolt captive, and a Nylon spacer (15) should be used between the coil mounting bracket and the Wing Nut.
- j) Choose the Coil you wish to search with, slide its Fibreglass tube (13) into the Intermediate Shaft (9).
- k) Adjust the Shaft lengths and Coil angle for a comfortable position. We recommend that shaft length be set to give a comfortable sweep length of approximately 2M. See page 18 for more details on detecting techniques.
- l) Wind the Coil Cable around the shaft and plug the Coil Connector (24) into the Coil socket on the control box. Ensure that the cable is firmly attached to the shaft **without strain** and cannot move around, especially near the Coil. Fasten the cable to the shaft with the supplied Velcro Straps (18). Leave enough slack at the bottom of the cable near the coil to allow for adjusting the coil angle without placing strain on the coil cable. If the cable can move around, especially near the coil it will be "seen" by the detector and cause random noises which can be very confusing.

- m) Feed the power cable through one of the holes (left or right) in the bottom of the lower pouch of the backpack. Fit the Battery into the lower pouch (16). NOTE: Only use 6 Volt Gel Cell Batteries. Place the Movable Barrier between the battery and the Termination Box. Plug the headphones (17) into the socket on the Termination Box.

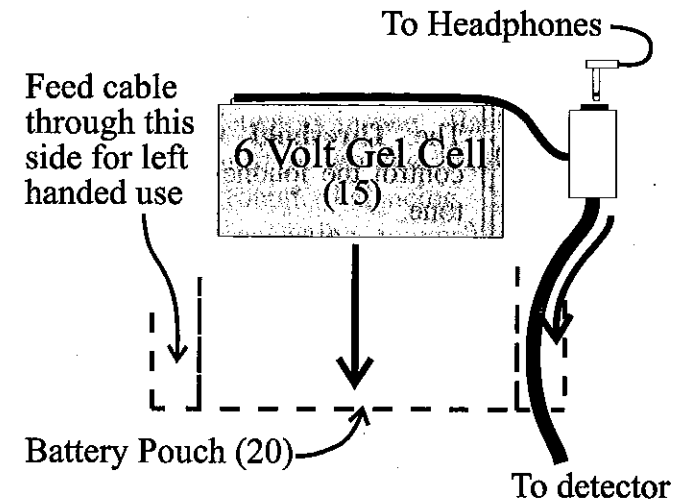

Figure 2

- n) Put on the Battery Harness. Ensure that the ON/OFF Switch on the detector is set to OFF. Plug the connector (22) on the battery harness cable into the power connector on the control box. This cable connects the battery and the headphones to the detector. The Shoulder Balance Strap (23) can be clipped to the Shoulder Balance Strap Clip (8) on the shaft to take some of the weight when prospecting. There is also an adjustable hand strap on the handle which allows you to relax and flex your fingers without putting the detector down.

**THE CONTROLS**

Figure 3

**The Rear Panel Controls****On / Off**

The **On/Off Switch** turns the power from the battery to the detector on and off. Always turn the detector **Off** before connecting and disconnecting the coil or battery pack, and when not in use.

**Threshold**

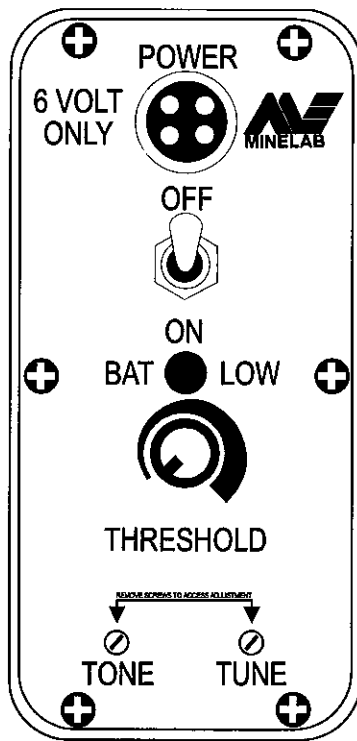
The **Threshold Control** is used to control the loudness of the background tone.

**Tone**

The pitch of the background tone can be adjusted to suit the individual using the **Tone Control**. The **Tone Control** is inside the box and covered with a screw in cap. The supplied screwdriver is used to remove the cap and adjust the Tone Control. This control has a rotation angle of 270°.

**Tune**

The **Tune Control** varies the **SD2100** internal sampling frequency slightly to minimise the effects of electromagnetic interference from sources such as power lines, radio transmitters, computer equipment and other metal detectors. The **Tune Control** is inside the box and covered with a screw in cap. The supplied screwdriver is used to remove the cap and adjust the Tune Control. This control has 15 turns from one end of the adjustment to the other and it will “click” very quietly to indicate the end of adjustment.

**The Front Panel Controls**

Figure 4

**Search Switch**

The **Search Switch** is used to select one of the two Ground Balancing modes or the Search Mode. Ground balancing should be carried out at the beginning of each search and when ground noise becomes unacceptable. The **SD2100** is essentially two detectors in one. Each “half” of the detector must be ground balanced separately. After ground balancing has been completed, prospecting is performed with the **Search Switch** in the ‘Search’ position. In this central position both “halves” of the detector operate simultaneously.

**Balance I and II**

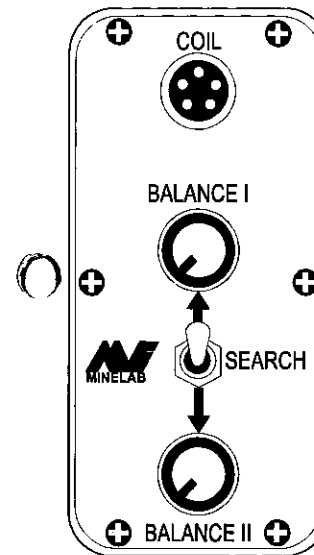
The ground is made up of many different chemicals. Some of these chemicals will produce a response from the detector. Some of these responses are welcome, and produced by metals such as gold and some are not welcome. The unwelcome responses are often called ‘ground noises’ and are caused by variations in the ground chemistry. This is often referred to as ‘ground mineralisation’. The **Balance Controls** allow the detector to be adjusted reduce the effects of ground mineralisation. Each control is adjusted with the **Search Switch** in the respective position. If the effects of ground mineralisation are not balanced, signals due to metal objects will be very hard to distinguish from ground noise.

**Headphones**

The **SD2100** does not have an external speaker, all audio is heard

## SD2100

through headphones. The headphones plug into the **Headphones Socket** on the Battery Cable Assembly.

### OPERATING INSTRUCTIONS

#### Detector Sounds

**Threshold:** This is the background tone produced by the detector. The loudness of the background tone is set with the Threshold Control. It should be set so that it can just be heard and the pitch of the threshold tone can be set to your personal preference using the Tone Control. The volume of the threshold tone of the **SD2100** will not decrease below the level set with the Threshold Control.

**Object Sound:** Abrupt variation of the Threshold tone volume and pitch. If the pitch drops first then rises as the coil is passed over a target this generally indicates a small target. Conversely if the pitch rises first then falls as the coil is passed over a target this generally indicates a large target.

**Ground Noise:** Irregular noises that are difficult or impossible to pinpoint when moving the coil over the ground. These noises are caused by the changing chemistry or "mineralisation" of the ground. These variations in Threshold Tone can be reduced to a very low level with adjustment of the Balance Controls as described in the "Ground Balancing" section.

#### Turn the SD2100 On

With the SD2100 assembled and the coil held away from the ground and metal objects switch the On/Off Switch On.

#### Set the Threshold Control

The **Threshold Control** should be set so that the background tone set just slightly above barely audible. It is important to know that small surface objects, as well as large deeply buried objects may

## SD2100

produce only very small changes in the threshold tone. It is therefore important to set the **Threshold Control** correctly to ensure these targets are identified. We suggest that you experiment with known targets to assist in setting this and the other controls.

#### Set the Tone Control.

After removing the screw in cap carefully adjust the Tone Control until background threshold tone is at a comfortable pitch for your hearing. It should be noted that interpretation of the detection signals involves discerning the difference between rising and falling pitch of the threshold tone. Once again we suggest you take the time to experiment with known targets to assist with the setting of this control. After adjusting the **Tone Control** replace the screw cap. Once control is set it probably will not need to be adjusted again.

#### Set Tune Control

With the **SD2100** operating and the **Threshold Control and Tone Control** set:

Hold the coil parallel to the ground at waist height and move the coil through an arc of 180°. Listen for an increase in interference as you move the coil. When the interference is at its worst, place the coil on the ground in this position. With the supplied screwdriver adjust the Tune Control to minimise the effect of the interference. The Tune Control should be adjusted at approximately 1 turn per 2 seconds. It may not be possible to remove the effects of interference completely, but you should be able to greatly reduce its effects. After adjusting the **Tune Control** replace the screw cap. Once this control has been set for the location you are in it should not require readjustment unless conditions change greatly.

#### Ground Balancing

It is important to "Ground Balance" the **SD2100** to the local conditions before commencing a search. For best results "Ground Balance" to the "noisiest" area of the ground you wish to search.

Assuming that the detector is operating with the Threshold and Tone set, adjust the Balance Controls using the following procedure:

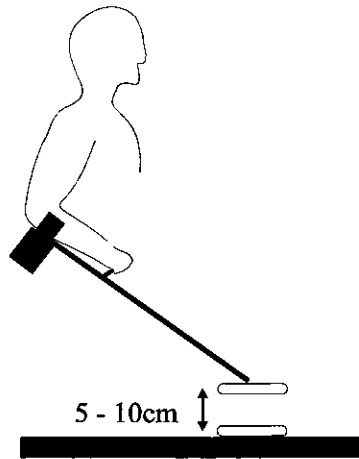

**Figure 5**

Set the Search Switch to the 'Balance I' setting. Move the coil up and down between 5cm to 10cm above the ground at about 2 seconds per complete up-down movement. As the coil moves up and down, the volume and the pitch of the threshold tone will change if the detector is not ground balanced.

Adjust the Balance I Control so that no variation in volume or pitch is heard as the coil is moved up and down.

When this is achieved the detector is said to be "Balanced" or "Ground Balanced". The greater the change in the volume or pitch of the threshold tone as the coil is moved above the ground the further out-of-adjustment the balance controls are.

When the detector is balanced with the Search Switch in the 'Balance I' position, switch to 'Balance II' and, using the Balance II Control, repeat the process described above. When the detector is balanced in both positions, switch to Search and commence prospecting. If "Ground Noises" become excessive while searching simply re-ground balance the detector using the technique described above. In ground with low mineralisation, ground noises will also be low and these controls will need little adjustment.

### The Batteries

The 6 Volt Gel Battery supplied with your **SD2100** will last for approximately 16 hours from being fully charged. When the charge of the battery drops to a low level, the BAT LOW light on the rear

control panel will flash. If the **SD2100** is operated when the "BAT LOW" light is flashing it may become unstable.

**NOTE: Only use 6 volt batteries. Never use a 12 volt battery as this will damage the detector. This damage is not covered by warranty**

Two different kinds of battery chargers (Mains and 12V) are supplied with the detector to facilitate charging of the battery under various conditions. Gel cells, unlike Nicads do not suffer from memory problems and may be recharged at any time during their discharge cycle. It is very important to fully charge Gel Cells before storage. Do not leave a battery fully discharged for longer than 1 day.

### Charging Batteries

Before disconnecting the battery in order to recharge it, turn the **SD2100 OFF**. The battery cable may then be disconnected from the detector and plugged into the appropriate charger.

### Mains Charger

The supplied mains charger will charge the Gel Cell Battery from the local mains (AC) power. Follow the 'Charging Batteries' instructions and plug the battery lead into the charger, then plug the mains charger into a mains outlet. Switch the mains outlet on. Check the charger name plate, it will be rated at 1A/Hr or 0.5A/Hr. The 1A/Hr charger will recharge a completely flat battery in approximately 10 hours, the 0.5A/Hr charger will take approximately 20 hours. Partially discharged batteries obviously require a shorter period to recharge. **Do not leave partially discharged batteries on charge overnight. Do not leave the mains charger on for extended periods as reduced battery life may result.**

### Vehicle Battery Charger

The Vehicle Battery Charger supplied with the **SD2100** will charge the Gel Cell Battery from the cigarette lighter socket of your motor vehicle. Follow the 'Charging Batteries' instructions and plug the



## **SD2100**

battery lead into the charger, then plug the charger into the cigarette lighter socket. The engine need not be running for the charger to work, but usually the ignition switch should be set to 'Accessories' to apply power to the cigarette lighter socket.

A red LED will flash while the battery is charging. When the battery is flat the LED may flash fast enough so as to appear constantly on, as the battery charges the LED will flash at a slower rate. Leave the battery to charge for approximately 10 hours using this charger.

If the battery voltage of your vehicle drops below 11V the charger will cease charging. This prevents the battery charger from flattening the vehicle battery. However, make sure your vehicle battery is in good condition before camping in remote areas. Run your engine above idle speed for at least 30 minutes each day to keep your vehicle battery charged.

Please Note: The charger is designed for use with vehicles which have a negative earth electrical system. Most cars made after 1970 will have a negative earth electrical system. If you plug the charger into a vehicle with a positive earth system, the fuse in the cigarette lighter plug will blow and the LED will not light.

### **Changing Batteries**

We recommend that you do not disconnect the battery from the battery cable. If you require a spare battery we recommend that you purchase another battery complete with cable assembly. It is not necessary to remove the battery from the Backpack to recharge it.

**If the battery is re-connected incorrectly you will damage your detector. This damage is not covered by warranty.**

## **SD2100**

### **The Search Coils**

The **SD2100** is supplied with three coils; an 18" Monoloop, 11" Double 'D' and an 8" Monoloop. The coils supplied with your new **SD2100** are compatible with the SD2000, however the coils supplied with the SD2000 may be noisy when used with an **SD2100**. The Monoloop coil consists of only one coil of wire and gives a detection pattern similar to a Concentric Coil. Double 'D' coils contain two 'D' shaped coils of wire which overlap and produce a "blade" like detection pattern.

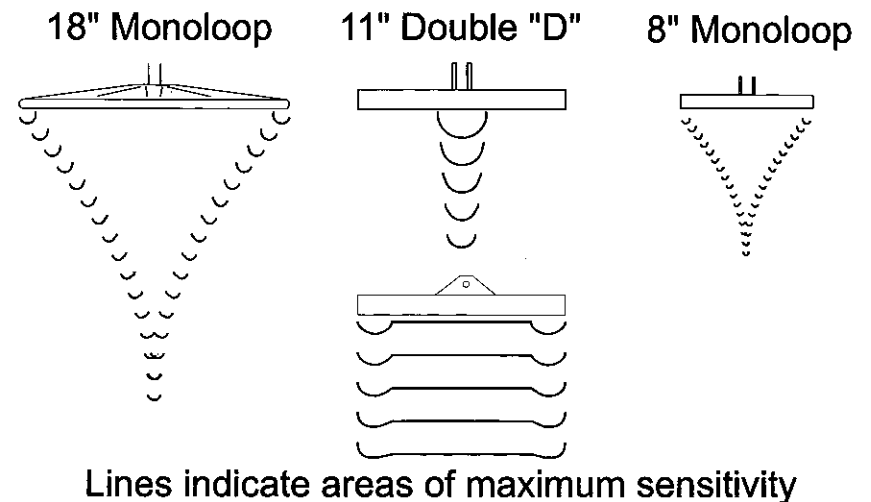

**Figure 6**

**DO NOT PLUG ANY SD SERIES COILS INTO ANY OTHER DETECTOR!**

**This action may damage other detectors and the damage is not covered by warranty.**

The following table will describe the characteristics of each coil:

Coil	Average Mineralisation	Highly Variable Mineralisation (hot rocks)	High Salt Concentration
8" Monoloop	Greatest depth on small nuggets	Can be adversely effected by some variable mineralisation	Good
11" 'DD'	Good, however 8" or 18" recommended	Good.	Good
18" Monoloop	Greatest depth on large and medium sized nuggets	Can be adversely effected by some variable mineralisation	Poor

## DETECTING TECHNIQUES

### Searching

The **SD2100** is a "motion" detector, which means that it must be moving in relation to a target in order to detect it.

The battery should be worn in the Backpack supplied. This places the battery at the furthest practical distance from the coil. If the battery is worn on your side the 18" Coil will detect it and cause false signals.

Ensure that you do not set your shaft length too short. If the coil is too close to your body it may detect your pick, the battery or any other metal which you may be carrying.

**Do not wear steel cap boots or shoes with metal eyelets!**

If you find that you are getting false signals as you sweep the coil ensure they are not produced by metal that you are carrying. Move the coil closer and further away from your body to determine if the signals are coming from items such as your pick or battery. If the signals are from these items take steps to increase the distance between the coil and these items.

The Coil should be swept over the ground in a side to side sweeping motion. Coupled with the slow forward motion of the operator, the search pattern resembles a snaking path. To ensure that the ground is thoroughly searched it is advisable to approach the area from 3 directions as shown in Figure 7.

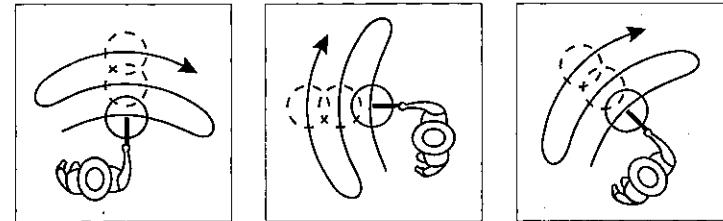

Figure 7

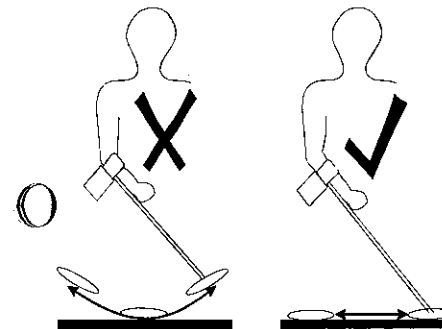

Figure 8

While sweeping the coil it is important to keep it parallel to, and at a constant height from the ground at all times. The easiest way to achieve this is to have the coil touching the ground. Be aware of any tendency to raise the coil at the ends of each sweep as this will reduce your detection depth.

Each sweep of the coil should overlap the area covered by the previous sweep to ensure a full coverage of the area being searched.

**Hints for maximum gold recovery:**

- a) Keep the coil as close to the ground as possible.
- b) Listen very carefully. This is more important than concentrating on looking.
- c) SLOW DOWN! Do not rush, take your time.

**Identifying Target Signals**

A summary of the sounds of the detector is given in the "Detector Sounds" section of the "Operating Instructions" chapter.

Metallic targets will usually give a "solid" sounding response when the coil is swept across the object from any direction. Ground noises usually give a broad irregular response when the coil is swept from different directions, whereas responses from a metallic target are generally narrow and sharp and mostly symmetrical.

If you are not sure whether the sound is ground noise or indicates a target, you need to further determine the validity of the signal. Scrape a shallow hole about 7 to 10cm deep over the suspected target. Sweep the coil over the hole at the original ground level; do not dip the coil into the hole. If the signal has decreased in volume and area it is a ground noise. If the signal remains the same or increases, it is a metallic target. If you are still not sure, make the hole deeper and repeat the process.

Be aware that this technique is not entirely reliable and should only be used once you have learned to interpret the various signals. The Halo Effect which is built up around a buried metal object making it appear to be larger to the **SD2100** than it actually is will be reduced once the soil has been moved. This can then cause the strength of the object signal to reduce which may then be mistaken for ground noise. For example, a small target can be detected at a substantial depth with the **SD2100** but may be barely, or not even detectable once recovered from the ground (even if reburied).

It is not recommended that you try to eliminate what might appear to be a faint, isolated ground noise by balancing the **SD2100**, as you may be balancing out the response from a deeply buried metallic target.

**Pin-Pointing**

In order to save time in the recovery of an object and to reduce the size of the hole required to extract it from the ground, it is necessary to pin-point the object's exact location. The technique described here will be particularly useful with the Double 'D' coil, but will also work with the 18" Monoloop.

When a likely object is detected, sweep the general area, taking note of where the strongest signal is received as the coil is moved over the object. By decreasing the length of the sweep it should be possible to draw an imaginary line in the ground where the strongest signal is located.

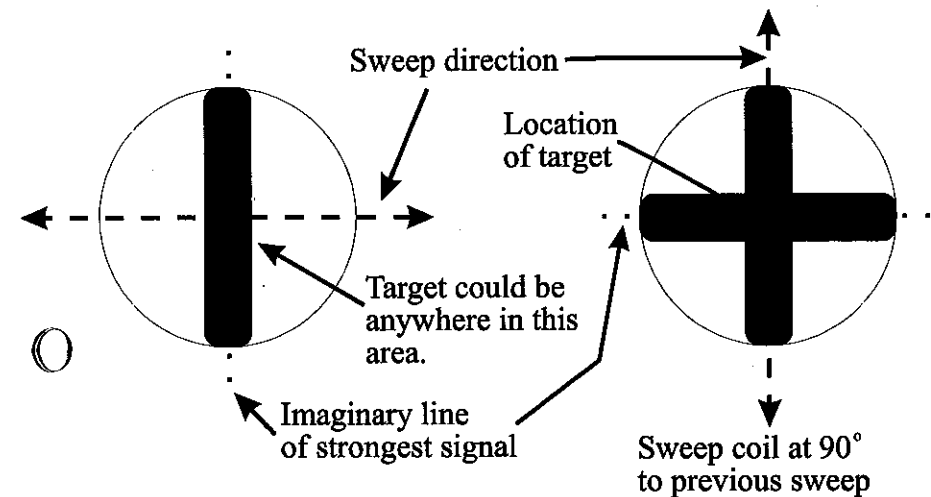
**Figure 9**

Now, move around the target so that you are facing the target at 90° to the initial direction and repeat the process. Where the two imaginary lines cross is where the object is located. Small shallow nuggets will give a signal near the rim of the 18" Monoloop. Turning the detector on its side and moving the coil while it is vertical may assist in pinpointing as shown in Figure 10.

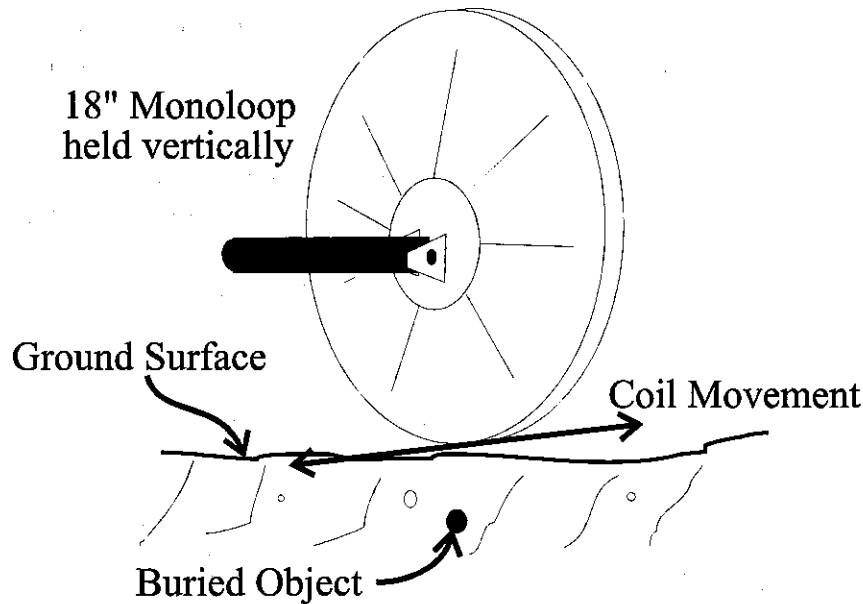

Figure 10

### Digging the Target

Once you have established the location of the target it is necessary to dig a small hole to recover it. In order to preserve the environment, it is essential to make the hole as small as possible and always replace the soil or grass which is removed.

It is essential to carry at least one of the following digging tools with you when searching. The best tools are:

- a small, strong digging spade.
- a pick.
- a shovel.
- a crowbar for very deep objects in hard ground.

Before digging, clear the area of loose surface material and check that the sound is still there. If it is not, the target must be amongst the surface material.

If the signal is still there, dig down a few inches. If the target is not visible, sweep over the hole. If the signal has gone then it must be in the pile just dug. Take care when you dig as damaging a nugget can reduce its value. We suggest that you start digging approximately 10cm in front of the target to reduce the chances of damage. Also, pile the diggings carefully as it might be necessary to search them systematically and it will also be necessary to replace them, just as they were dug, once your search ends.

If it becomes evident that the target is located in the removed soil pile, sweep the coil over the pile. Be sure that there are no objects buried in the soil beneath the pile. Use the method of progressively halving the pile which has the target within it. If it is still difficult to find the target, lay the detector down with the search coil flat on the ground. Take a handful of the diggings and pass it over the coil. If there is no signal, place the handful carefully away from the pile and repeat with another handful. Of course, your hands and wrists must be free of any metallic jewellery and watches.

Once the object has been recovered it is a good idea to sweep the hole again to ensure that there are no other targets to be detected. When you have found an object in a particular hole, search the surrounding area very carefully as it is very likely that there are more objects nearby. **Fill in the holes.** If you heard a target, keep searching until you find it; it is there and may be valuable.

**Digging Deep Targets**

The **SD2100** has unparalleled depth capabilities which will surprise experienced and new prospectors alike. If the target appears to be deeply buried it will help to follow the following technique.

Use the cross sweeping method to locate the target as accurately as you can. Scrape a hole large enough to take the coil and about 10 cm deep.

Turn the detector coil onto its edge, making it vertical, and probe various sections of the hole listening for the loudest reading. The 18" Monoloop is responsive at all parts of its edge. The 8" is better for precisely locating an object. Once the target is recovered: **Fill in the hole.** If the object you find is not valuable please remove it, take it with you and dispose of it in the proper manner. Removing rubbish and refilling holes will help metal detector operators gain a good reputation and lead to more areas being opened up for prospecting.

**Salty Environments**

The **SD2100** will find objects at great depth in salty environments, however the interfering signals caused by the saturated salt or highly concentrated salt can not be completely "balanced out." The **11" Double 'D'** or the **8" Monoloop** coil will give best results in salty conditions.

**PROSPECTING TIPS****The SD2100**

The **SD2100** has superior ground cancelling and it is possible to find quite large objects near the surface in well worked areas simply because other detectors have been unable to cope with the high degree of mineralisation. In light of this, you should not ignore what can seem to be 'unlikely' responses. In other words: Dig all signals even in "thrashed" areas.

Very large variations in the mineralisation of an area can produce a signal in the detector. Typically in the Victorian goldfields you might get a response from a concentration of orange/reddish dyke material or clay. Similarly in the loamy conditions of Western Australia a pocket of dark orange/reddish colouration might produce a sudden signal variation. However, it is not recommended that you try to ground balance the detector in an attempt to cancel a questionable response. This can produce cancellation of weak signals from very deep targets. If in doubt, scrape away some soil above the suspect signal; if the signal gets stronger, its a target. Dig! In such areas the 11" Double 'D' is recommended. If the ground is extremely variable and causes the detector to be very noisy you may try operating with the Search Switch set to Balance I. Whilst this will reduce noises caused by the varying mineralisation, some nuggets will not be detected. This is because the full range of nuggets is not detected in Balance I or Balance II, but only when the Search Switch is set to Search

**Charcoal**

Charcoal can sound loud at times and rather like a metallic object when close to the surface. Charcoal is usually created by farmers burning off tree stumps or by bushfires. The growth is burnt below the ground level, so it is not always obvious what the sounds are until you have actually dug up the causes of these noises a few times. Once the charcoal is removed from the ground the signal will vanish.

**MAINTENANCE****Care of Your SD2100**

The **SD2100** is a high quality electronic instrument which is finely engineered and housed in a durable container. Taking care of it is mostly common sense.

- It is very important to keep the connectors clean and **vitaly important to keep them dry.**

- Do not expose the detector in high temperatures or in the sun longer than necessary. Shading it will help protect it. Avoid leaving it in a closed vehicle, especially in the sun.
- The Search Coil housing will wear through if you scrub the ground with it while searching. We recommend that you use a replaceable skid plate on the 8" and 11" coils to protect them. The 18" Coil is made from wear resistant Kevlar®. However with constant abrasion it will wear through. Extra protection can be gained by covering the perimeter of the coil with a silk tape such as Leukosilk® which is available from chemists. The use of some other tapes, such as insulation tape, may result in loss of performance.
- The Control Box is not waterproof, even though it has been designed to be water resistant. Avoid getting it wet.
- The Control Box and Coils must not come into contact with petrol or other oil based liquids.
- If any part of the detector comes into contact with corrosive substances, including salt or salt water, it must be washed with fresh water. Keep the unit dry and clean. Do not use solvents to clean the detector; use a damp cloth with mild soap detergent.

**TROUBLESHOOTING**

Use the following table to check for problems which can be diagnosed by you:-

<b>Fault</b>	<b>Suggestion</b>
No Sound	Turn Threshold control fully clockwise. Check cable connections Check Headphones Check battery
Threshold tone but no object detection	Check coil connection

<b>Fault</b>	<b>Suggestion</b>
Random noises	Charge battery
Battery will not charge from vehicle battery	Check for power to cigarette lighter socket.

In the unfortunate circumstance that you need to return your detector to Minelab for service please fill out the Fault report form on page 30 and enclose with the detector. Please supply as many details as possible as this will assist our service engineers to rectify the fault quickly and efficiently.

**WARRANTY**

There is a two year parts and labour warranty on the **SD2100** control box. Refer to your Warranty Card for details. The Search Coils are warranted for one year. Refer to your supplier or Minelab for service, either in or out of warranty.

NOTE: This warranty is not transferable, nor is it valid unless the enclosed warranty registration card is returned to Minelab Electronics Pty. Ltd. or an authorised Minelab Electronics Pty. Ltd. regional distributor within 14 days of the original purchase, for the purpose of recording the date, which is the actual commencement of the warranty.

The Minelab warranty does not cover damage caused by accident, misuse, neglect, alteration, modifications or unauthorised service. For specific details of the Minelab warranty please refer to the machine's 'Product Warranty Card'. Please note it is the owner's responsibility to transport the detector to Minelab for repair in or out of warranty.

**SPECIFICATIONS**

(subject to change without notice.)

Length	Max	1.3m			
	Min	1.1m			
Weight	Complete (Exc. Batt)	2.4kg			
	Configuration	Shaftmount	Yes		
		Hipmount	No		
Transmission	Multi Period Sensing				
Ground Rejection	Dual Ground Balance				
Search Mode	Motion				
Controls	On/Off	2 Pos Sw	○	○	
	Threshold	1 Turn			
	Balance I	10 Turn			
	Balance II	10 Turn			
	Tone	1 Turn			
	Tune	15 Turn			
	Search	3 Pos Sw			
	Audio O/P	Loudspeaker	No		
		1/4" Headphone Jack	Stereo/Mono		
	Batteries	6V 10 A/Hr Gel Cell			
Duration		16 Hrs+			
Search Coils	8" Round	Windings	Monoloop		
		Weight	520gm		
	11" Round	Windings	Double 'D'		
		Weight	720gm	○	○
	18" Round	Windings	Monoloop		
		Weight	850gm		
	Cable Length all Coils	1.2m			
Patents	AUS 602132, AUS 633536 US4890064, others pending.				